

Mounting frames for wall-mounted WC | Load-bearing and light weight walls



---

**SmartiKa 6E technical data sheet**  
**Standard code 377106**

---

## Sommario

DESCRIPTION	3
FEATURES	3
STRUCTURE FEATURES	4
CISTERN FEATURES	4
DIMENSIONS	5
STANDARD SUPPLY	6
ON DEMAND	6
PACKAGING	6
ACCESSORIES AND SPARE PARTS	7
LIST	8

## Smartika 6E

Mounting frame for wall-hung WC suitable for load-bearing, pre-existing load-bearing, lightweight and plasterboard walls according to the specific kit supplied.

### DESCRIPTION

Mounting frame for wall-hung WC equipped withj Kariba 6E cistern (4,5/6lt). According to the specific kit supplied, is suitable for load-bearing installations, pre-existing load-bearing installations, lightweight walls and plasterboard.

### FEATURES

#### Features and plus



For wall-hung wc



For lightweight walls and plasterboard (according to the specific kit supplied)



For load-bearing and pre-existing load-bearing walls (according to the specifi kit supplied)



6lt in-wall cistern (adjustable to 4.5lt)



Dual flush with adjustable partial flush (from 2.5 to 3.5lt)



Maintenance operations in 5 minutes



Assembly operations in 5 minutes



FLEXVALVE



Monoblock container



Lago system



NORMA-PLUS float valve, acoustic cl.1, LGA-TUV (standard for code 377106)



100% Made in Italy

## STRUCTURE FEATURES

- Painted steel frame
- Structure certified to bear 400kg according to standards UNI EN 977/1-997-89500/2 if installed / walled correctly

## CISTERN FEATURES

- 6 liters HDPE monoblock container without junction points
- Repairable in case of accidental drilling
- Plaster holder fixing mesh (according to code)
- Extruded closed-cell PE insulation, anti-condensate and soundproofing with thermal resistance
- FlexValve: discharge valve with silicon gasket. Made of polypropylene with silicone additive (PTE)
- NORMA-PLUS float valve, acoustic class 1, LGA-TUV approved adjustable between 6 and 4.5lt (standard for code 377106)
- Maintenance operations without using tools
- Pneumatisable without the need to replace internal components

## DIMENSIONS

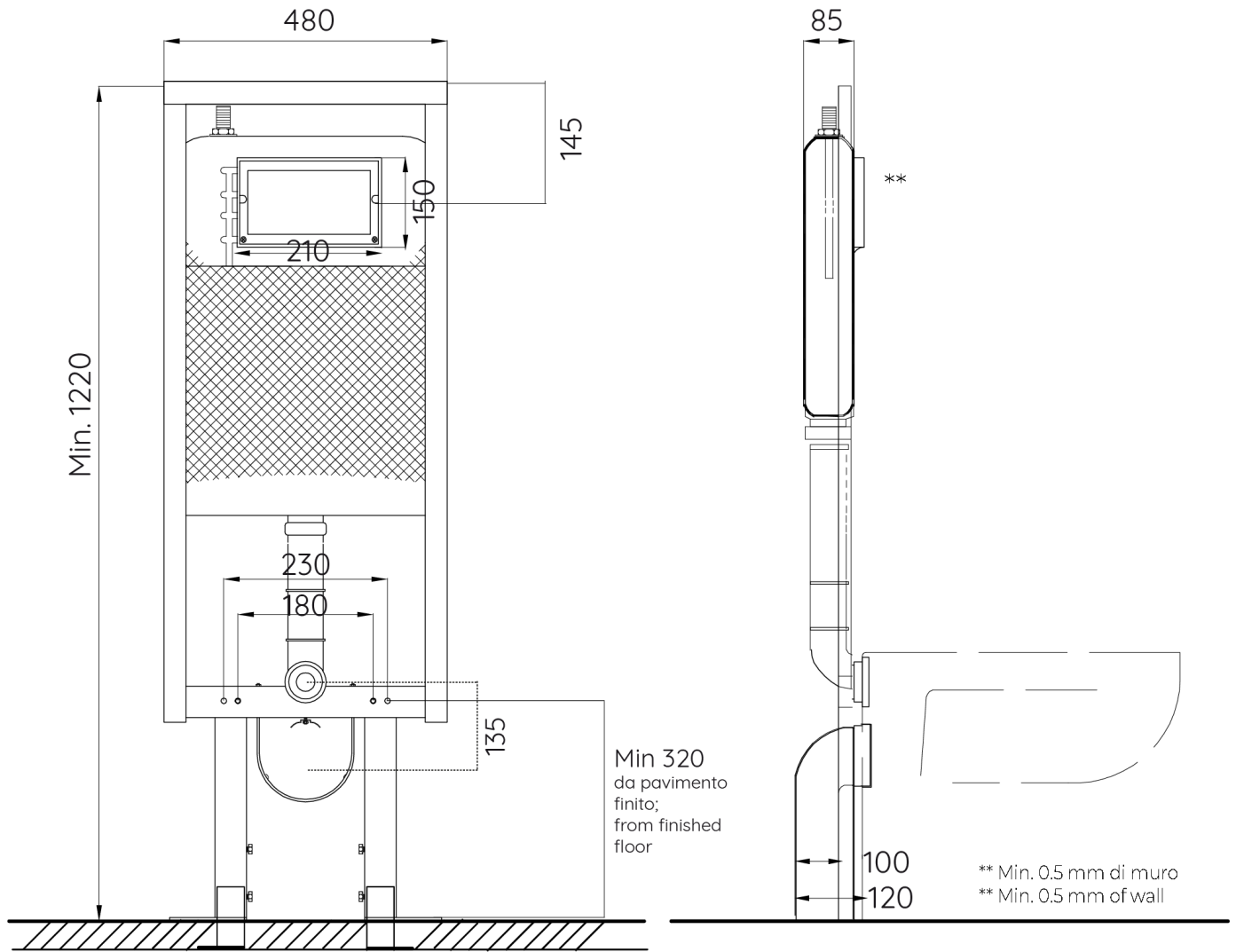

S

## STANDARD SUPPLY

- Painted steel frame
- Kariba 6E cistern fixed on frame
- Fixing brackets for load-bearing walls
- WC fixing centre distances for M12 threaded bars adjustable to 180 mm and 230 mm
- M12 threaded rods for WC fixing with nuts, protective sleeves and caps
- White pipe for connection to wall-mounted WC and clamp gasket
- $\varnothing$  90mm black sleeve with gasket
- Black outlet bend 90°  $\varnothing$  90 mm
- Dismountable stop valve 3/8"-3/8" including fitting 1/2"-3/8"
- Protection template to shape perimeter of tiles or plaster
- Protection caps for discharge pipe and outlet bend

IT NEEDS TO BE INTEGRATED WITH DUAL COUNTERPLATE COD. 317010

## ON DEMAND

- Dual counter-plate
- Dual flush plate Fidia/Itaka/Aurea
- 90/110mm adaptor
- 90/100mm adaptor
- Fixing kit for plasterboard, lightweight walls and pre-existing load-bearing walls
- Pneu system
- Kit to diagonalize the outlet bend

S

## PACKAGING

CODE	PCS	LxDxH	KG
377106	1	1230X495X150	11



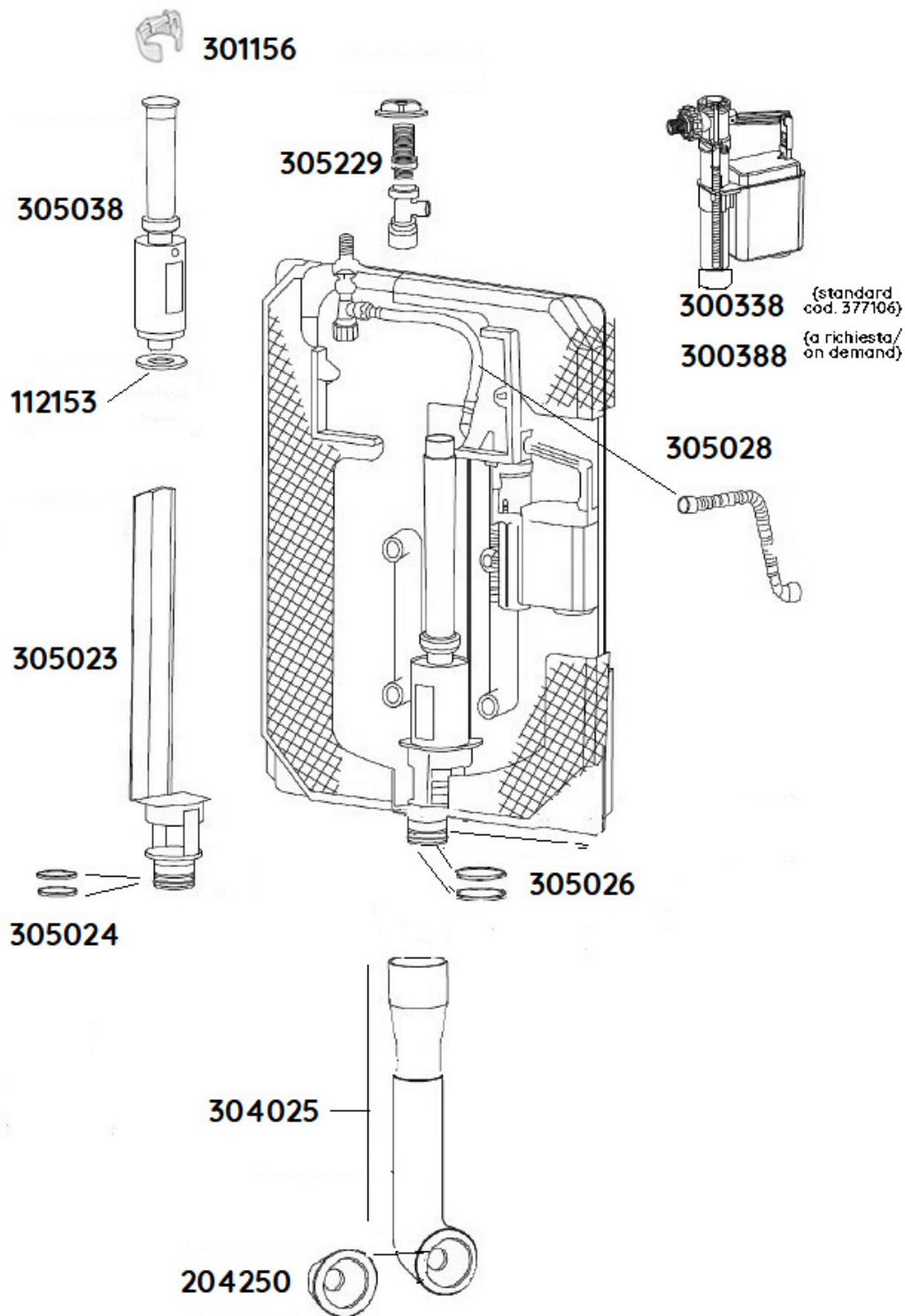















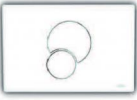
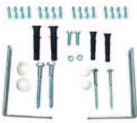

## ACCESSORIES AND SPARE PARTS

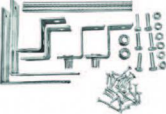

ACCESSORI INCLUSI  
INCLUDED

NON INCLUSI  
NOT INCLUDED

ACCESSORI A RICHIESTA  
ON DEMAND

 cod 368403	 cod 379081 Ø90	 cod 301156 cod 305038	 cod 317010 controplacca duo - counter plate	 cod 369088-P	 cod 379080 Ø 90/110
 cod 204015 Ø40 cod 204016 Ø32	 cod 369080 Ø90	 cod 305229	Aurea Fidia Itaka  Placca comando Control plate	 cod 369088	 cod 820561 Ø 90/100
 cod 305023	 cod 300388	 cod 300338*	 cod. 400190	 cod. 400195	 cod 300060
 Kit barre WC M12 completo M12 WC Bar Kit complete			 cod. 400194	 cod. 400197	 cod 300061
					 cod 617004 Ø100/110
					 cod 820560 Ø 90/110

LIST

Smartika 6E	
CODE	DESCRIPTION
305229	Dismountable brass stop valve 3/8"-3/8" including fitting 1/2"-3/8"
305028	Flexible hose with gasket L. 280 mm 3/8" - 3/8"
300388	Norma float valve 3/8" for concealed cisterns (on demand according to the code)
300338*	Norma Plus float valve 3/8" for concealed cisterns, acoustic class I (standard for cod. 377106)
305023	6E removable drain with lip gaskets
305024	Lip gaskets for 6E drain
305038	6E discharge valve
301156	Red anchor



Smartika 6E	
112153	Silicon gasket for discharge valve $\varnothing$ 60/21 mm
304025	Insulated discharge pipe set, complete with conic gasket
204250	Universal conic gasket $\varnothing$ 60x32/40 mm
305026	O-ring gasket for discharge pipe coupling
369080	Black outlet bend 90° $\varnothing$ 90 mm (standard for cod. 377106)
379080	Black outlet bend 90° $\varnothing$ 90/110 mm
379081	Black sleeve with gasket $\varnothing$ 90mm (standard for cod. 377106)
617004	Concentric sleeve $\varnothing$ 100/110 mm
820560	Adaptor $\varnothing$ 90/110 mm
820561	Adaptor $\varnothing$ 90/100 mm
123003	M12 threaded bars for WC fixing, complete with nuts and protective covers
204015	White pipe $\varnothing$ 40 mm + clamp gasket $\varnothing$ 40 mm for connection to wall-mounted WC (standard for cod.377106)
204016	White pipe $\varnothing$ 32 mm + clamp gasket $\varnothing$ 32 mm for connection to wall-mounted WC
368403	Fixing brackets (standard for cod. 377106)
300060	Universal Smartika fixing kit for every installation (on demand)
369088	Smartika fixing kit for back-to-wall, light masonry wall, plasterboard (on demand)
369088-P	Smartika fixing kit for back-to-wall and light masonry wall (on demand)
369085	Pair of fixing caps for wall-hung WC
300061	Kit to diagonalize the outlet bend
400190	Pneu transforming kit with aluminium inspection plate and remote white hand-button
400194	Pneu transforming kit with aluminium inspection plate and remote inox leg-button
400195	Pneu transforming kit with aluminium inspection plate and remote white plastic leg-button for floor/wall
400197	Pneu transforming kit with aluminium inspection plate and remote white hand-button